



Installation Instructions

For Part Numbers:

310-205 700-452 Airaid Oiled Media Filter
 311-205 701-452 SynthaMax Dry Media Filter - Red
 313-205 703-452 SynthaMax Dry Media Filter - Blue

2005-07 Jeep Grand Cherokee
 3.7L V6

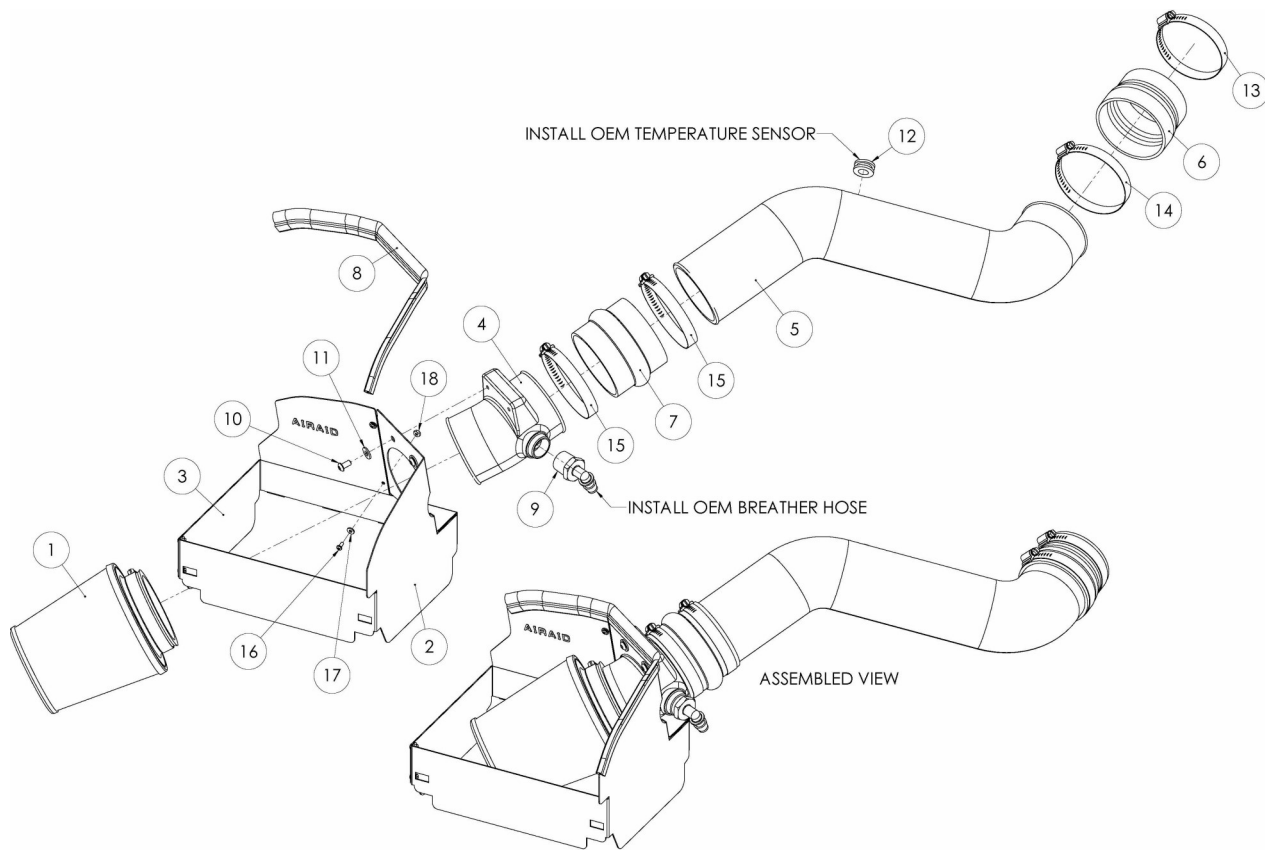

Component Identification

| | | |
|-----|-------------------------------|---|
| 1. | Airaid Premium Filter | 1 |
| 2. | MAF Panel | 1 |
| 3. | Front Panel | 1 |
| 4. | Air Filter Adapter | 1 |
| 5. | Modular Intake Tube | 1 |
| 6. | Reducer | 1 |
| 7. | Hump Hose | 1 |
| 8. | Weather Strip 17" | 1 |
| 9. | 90° Nylon Fitting | 1 |
| 10. | 1/4-20x1/2" Button Head Screw | 2 |
| 11. | 1/4" Flat Washer | 2 |
| 12. | Rubber Grommet | 1 |
| 13. | #48 Hose Clamp | 1 |
| 14. | #52 Hose Clamp | 1 |
| 15. | #56 Hose Clamp | 2 |
| 16. | 6-32x5/16" Phillips Screw | 5 |
| 17. | #6 Flat Washer | 5 |
| 18. | 6-32 Keps Nut | 5 |
| 19. | Airaid Decal | 1 |

Full color instructions can be viewed on our web site at Airaid.com. Use the **Product Search** function to find your part number, and click **View Details**.



1. **Disconnect the negative battery cable.**
Loosen the hose clamp that holds the factory intake tube to the resonator.



2. Unlatch the two clips on the factory air cleaner box lid.



3. Disconnect the factory breather tube from the air cleaner box lid.



4. Remove the air cleaner lid, and factory intake tube from the resonator box.



5. Remove the factory air filter.

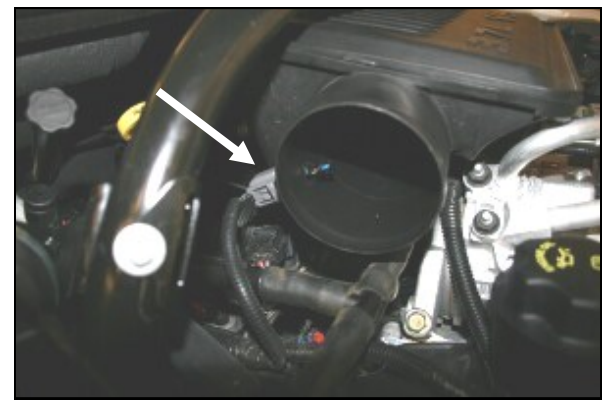

6. Disconnect the intake air temperature sensor wiring harness, by squeezing the tab on the side, and sliding the connector off.



7. Using the 5/16" socket, ratchet and extension (or flat blade screw driver)- loosen hose clamp on the throttle body. This clamp is located close to the fire-wall, in the center of the engine compartment.



8. Remove the factory intake resonator box from the throttle body by pulling the box towards the radiator and then lifting up.



9. Assemble the Quick Fit panels as shown, using five 6-32 screws (#16), #6 washers (#17), and keps nuts (#18). Apply the Airaid Foil Decal onto the Panel as shown.



10. Install the 90° nylon fitting (#9), into the air filter adapter.

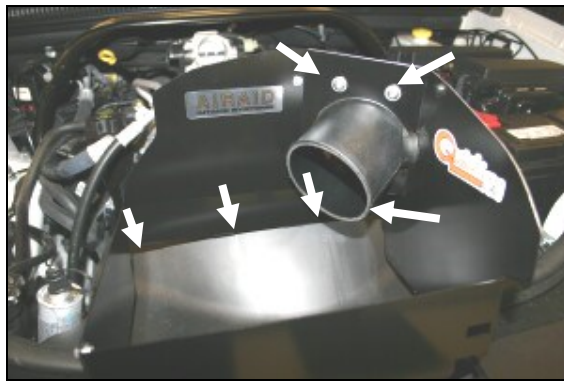

11. Install the Quick Fit panels into the factory lower airbox by lining up the three tabs in the rear of the panel, the latch holes in the front, and then re-latching the factory airbox clips. Next, using the 1/4-20x1/2" button head screws (#10) and 1/4" flat washers (#11), install the air filter adapter into the Quick Fit Panel.

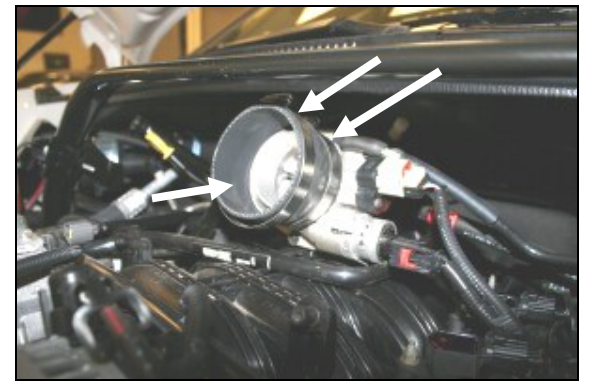

12. Install the provided reducer (#3) onto the throttle body with the smaller diameter towards the throttle body. Place the #48 hose clamp (#6) on the smaller diameter section of the reducer (throttle body side). Place the #52 hose clamp (#7) on the larger diameter side of the reducer. Leave the clamps loose for now.

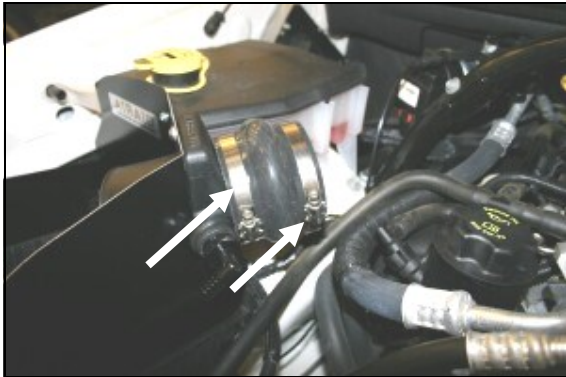

13. Install the provided hump hose (#7) onto the air filter adapter. Place a #60 hose clamp (#15) on each side of the hump hose. Tighten only the clamp on the air filter adapter. Leave the other clamp loose for now.



14. Remove the factory intake air temp sensor from the resonator box by carefully twisting the sensor body, and pulling it straight out of its mount. Place the sensor in a safe location, it will be re-used in step #15.

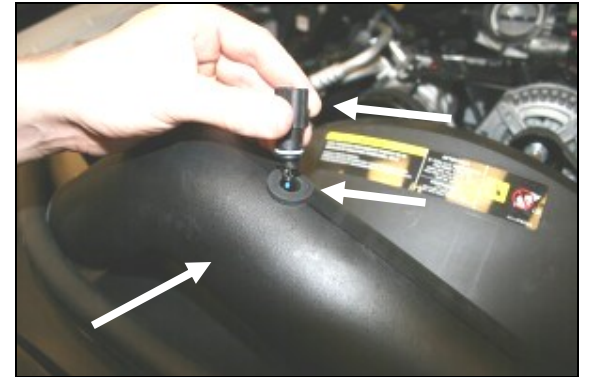

15. Install the rubber grommet (#12) into the Modular Intake Tube (#5). Next, slide the factory intake air temp sensor into the grommet in the tube. Make sure it is seated all of the way in.



16. A.) Install the Modular Intake tube into the hump hose end first. B.) Insert the opposite end of the Modular Intake tube into the reducer, on the throttle body. Adjust components for fit, and then tighten all of the hose clamps, and reconnect the factory intake air temp sensor wiring harness.



17. Install the Airaid Premium Filter (#1) onto the air filter adapter. Next, install the weather strip (#8) on the top of the Quick Fit panels as shown.

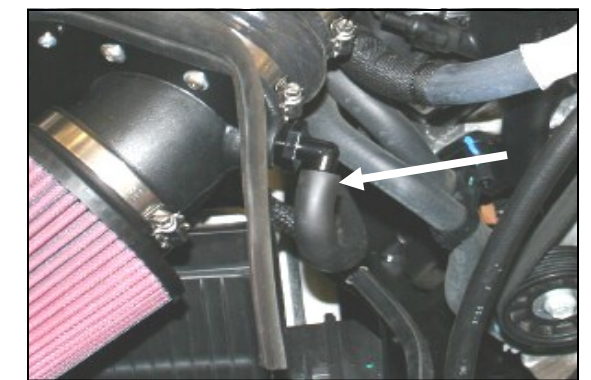

18. Reconnect the factory breather hose onto the 90° nylon fitting (#9).

19. Double check your work!

Make sure there is no foreign material in the intake path.
Make sure all clamps, hoses, bolts, and screws are tight.

20. Reconnect the negative battery cable!

Thank you for purchasing the Airaid Intake System. Contact Airaid @ (800) 498-6951 8:00 AM - 5:00 PM MST weekdays for questions regarding fit or instructions that are not clear to you. Your Airaid Intake System was carefully inspected and packaged. Check that no parts are missing, or were damaged during shipping. If any parts are missing, contact Airaid. The air filter element is protected from direct exposure to water and debris; care should be taken not to drive through deep water. WATER INGESTION IS THE DRIVERS RESPONSIBILITY! The air filter is reusable and should be cleaned periodically.

FILTER IDENTIFICATION

700-452 Airaid Oiled Media

701-452 Airaid SynthaMax Dry Media - Red

703-452 Airaid SynthaMax Dry Media - Blue

For your Oiled media filter we suggest using the AIRAID Filter Tune-Up Kit!



P/N 790-551 Aerosol Spray
P/N 790-550 Squeeze Spray



SynthaMax

Do Not Oil

Synthamax Air Filters do not require oil. Service air filter as needed by cleaning with common non-petroleum all-purpose household cleaner and water. Simple Green®, Formula 409® or equivalent works great. Apply cleaner to outside of air filter and allow to soak. Then flush filter clean from the inside out with a garden hose and repeat steps if necessary. Do not apply high pressure water or air to clean filter. Allow filter to air dry and reinstall.